

DECKS



Common Deck Stair Defects

Build deck stairs according to best practices rather than code to protect your customers and avoid liability

BY BRUCE BARKER

As an ASHI home inspector, I inspect decks every day. Most have multiple defects, which is to be expected on older decks. But I also find serious problems with recently built decks, which is less understandable. In particular, I like to focus on stairs, because of the role they play in deck safety.

Indoors or out, stairs are one of the most dangerous systems anywhere in a building. Falls involving stairs can result in serious personal injury; that's where the big money is for attorneys. On a deck, stairs are third (behind ledger detachment and guard failures) in terms of number of injuries suffered.

STAIRS BUILT RIGHT

Interior and exterior stairs share almost all of the same requirements. If anything, deck builders should be more careful about applying current safety and structural standards to exterior stairs because they are subject to environmental conditions that may exacerbate safety and structural problems.

But which standards apply? It's best to think of building codes as minimum standards, not as the standards for contractors who build quality decks. Keep in mind that even when a deck complies with a local building code, the code official who inspects it is not

Deck Stair Requirements

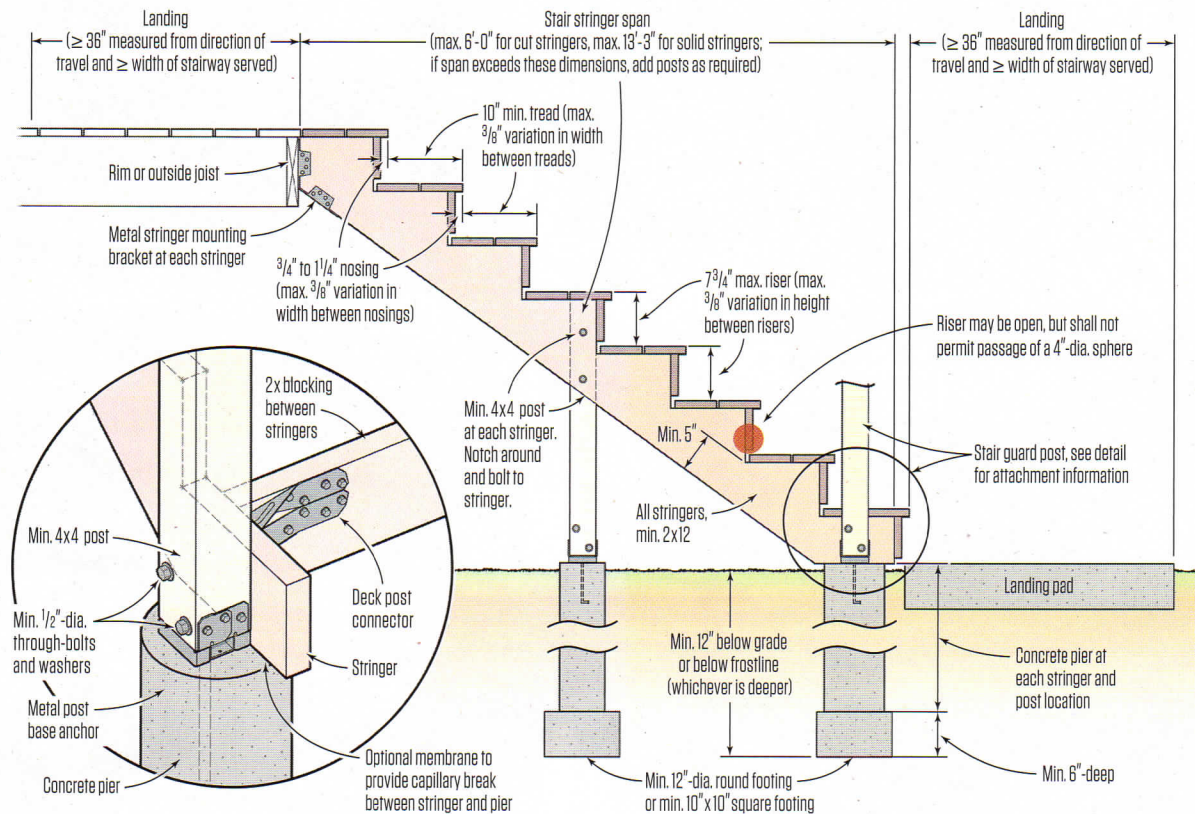

Shown here are DCA 6 recommended standards for deck stair stringers, risers, treads, and landings, and the components that support them. Note that in the stair example shown here, two posts and piers support each stringer; a typical 36-inch stair with three stringers requires six post and pier supports. Extending piers below frost depth is critical in cold climates where frost heave could lift the landing at grade. Wet and clayey soils are most at risk for substantial heave.

responsible for ensuring that the deck is safe.

To improve safety and to reduce liability risk, deck builders should follow current best practices as presented in the latest edition of DCA 6, the American Wood Council's *Prescriptive Residential Wood Deck Construction Guide*. Accordingly, I define "defect" as a failure to comply with these best practices. In fact, since a deck that passes local code inspection may still be unsafe, I believe that DCA 6 should be the standard to which all decks are built, regardless of what might be allowed by local building codes.

STRINGERS

Before getting into deck stair defects, let's look at how DCA 6 recommends that stairs should be built, starting with the stringers, risers, treads, and landings, and the components that support

them (see "Deck Stair Requirements," above). When I'm evaluating a deck stair, this is where I start.

Stringers typically have two bearing points, with the plumb (vertical) cut bearing on a rim joist or on a beam, and the seat (horizontal) cut bearing on—at minimum—a solid landing. To help resist both vertical and lateral loads, stringers require proper support and attachment at these bearing points. Without proper support, vertical loads (gravity) can pull the stringers down from their bearing points, while lateral (horizontal) loads can pull the stringers away from their bearing points. Most builders worry more about vertical loads, but lateral loads are also a frequent cause of a deck stair failure: The fasteners withdraw from the bearing point, then gravity takes over.

Seat cut. DCA 6 recommends supporting the stringers using



TOP ROW: The bottom of the stringer also needs adequate bearing: At least 1½ inches of the heel of the seat cut should bear on the landing. This example (1) is prone to splitting along the grain. Stringers also require adequate bearing on either a rim joist or a dropped header. Without it, the stringer can split along the grain (2, 3).

SECOND ROW: Fastening stringers with nails through the header into the end grain of a stringer (4) has minimal resistance to withdrawal. Toenailed stringers are less susceptible to withdrawal, but the connection can still fail as the framing ages and is structurally compromised (5). At a cost of a few dollars each for the connectors and recommended fasteners, the most cost-effective way to hang a stringer is with metal hardware. But this one (6) has been installed incorrectly: The stringer isn't fully bearing on the connector seat. Another red flag: The fasteners are drywall screws instead of approved connector nails.

posts that bear on footings, but this is an installation detail that I can't recall ever seeing. If there is good stringer bearing on a solid landing, and if the stringers are restrained against lateral movement, I usually declare victory and move on. But I live in a warm climate, where we don't have to worry about frost heaves that could move the stringers and loosen the connection at the plumb cut. Those who build decks in cold climates should consider using the DCA 6 details.

It's best if the entire stringer seat cut bears on a solid landing, but at minimum, at least 1½ inches of the seat-cut heel should bear on the landing. Allowing the toe of the seat cut to be the only part of the stringer that bears on the landing can cause the stringer to shear along the wood grain (1).

Plumb cut. For maximum plumb-cut bearing and fastening

area, the ideal stringer position has the top tread even with the deck flooring, which allows the stringer plumb cut to fully bear on the rim joist or beam. This location makes installing the stair guards and handrails more difficult, however, so it's more common to see the top tread dropped one riser below the deck flooring. Unfortunately, I've found that this often leads to unsafe attachment details with inadequate bearing that can allow the stringer to shear along the grain (2, 3).

Stringer attachment. One of the most serious deck stair defects is a poor connection between the stringers and the deck. Failure at this important connection is common, particularly when the stringers have been nailed to the framing, because nails are subject to withdrawal.

For example, I often see stringers fastened to a dropped header



A 2x12 stringer has a maximum unsupported span of 6 feet. These stairs (7) are likely to deflect and cause the stringers to either pull loose from the framing or shear along the grain. The problem is made worse with overcut notches, which weaken a stringer (8). The minimum recommended depth of the uncut portion of the stringer is 5 inches, as measured to the closest saw kerf and not the notch itself. Shown in the illustration on the facing page are the recommended standards for deck stair guards, which are subject to the same requirements as interior stairs.

with nails driven into the stringers' end grain (4). If the stringers are also bearing on—but not attached to—a landing and have no other attachment to resist lateral loads, the nails will do little to prevent the stringers from pulling away from the framing. If the stringers are bearing on the ground, the problem is even worse.

Sometimes the stringers are toenailed to the deck framing (5), an attachment method where the nails aren't quite as subject to withdrawal. Sometimes this method works—if an adequate quantity of the correct kind of nails is properly installed (there are rules about how to correctly install toenails), and if the wood and the nails maintain their integrity over the life of the deck. That is a lot of ifs.

To avoid extra work and eliminate drop headers, end-nailing, toenailing, and other questionable stringer connection methods,

DCA 6 recommends the use of metal hardware specifically designed for stringers, such as Simpson Strong-Tie's LSCZ or LSSU connectors. At a cost of a few dollars each for the connectors and recommended fasteners, this is the most cost-effective stringer connection method.

But in order to provide both the vertical and lateral support for the stringers, these connectors must be installed according to manufacturer's instructions. For example, stringers should fully bear on the connector seats. Screws are not allowed—unless specifically allowed by manufacturer's instructions, and then only manufacturer-supplied screws may be used. Deck screws and drywall screws are not allowed (6). Finally, the round and oblong holes are there for a reason: They are saying, "Put a fastener here."

Stringer construction. Almost all stringers on deck stairs are

Stair Guard Requirements

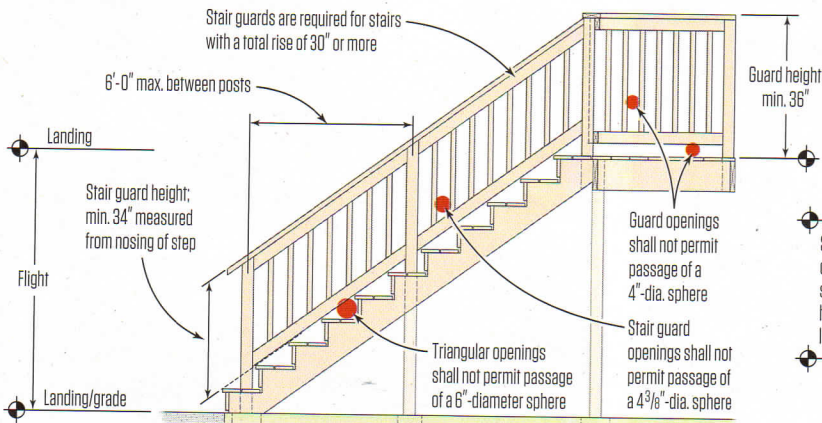

Handrail Requirements

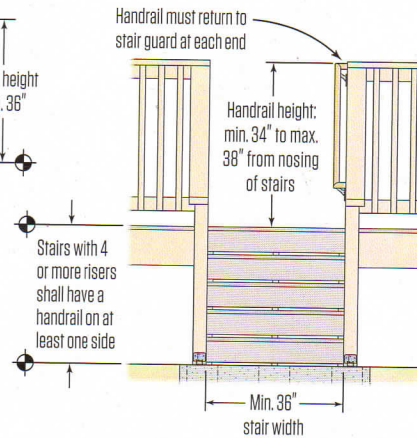

Stair Guard Requirements

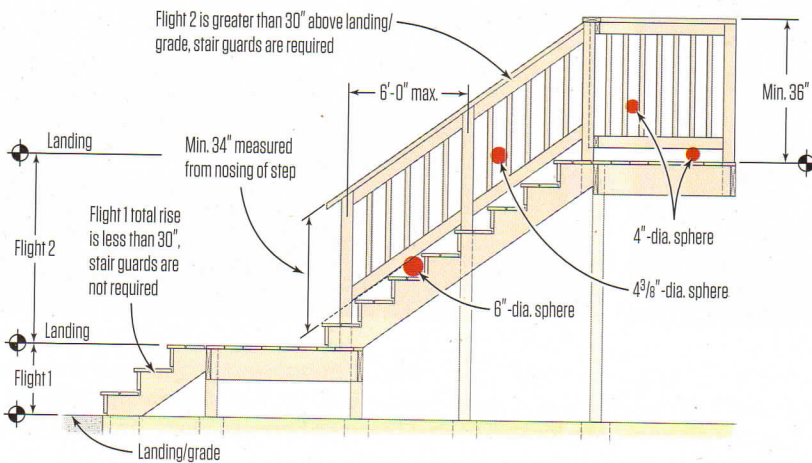

Handrail Mounting

Type I Handrail

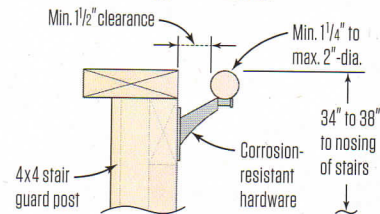

Type II Handrail

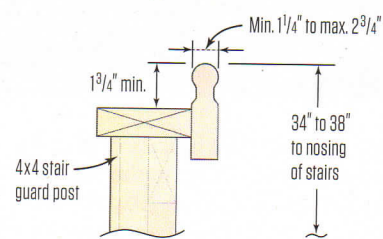

cut stringers. The two most common cut-stringer defects that I see are overspanning and overcutting.

The minimum recommended size for a deck stair stringer is 2x12, which has a maximum recommended unsupported span of 6 feet. Often this maximum span is dangerously exceeded, resulting in overspanned stringers that will deflect and cause the connection at the deck to pull loose and fail. In some cases, overspanned stringers may shear along the wood grain (7).

The minimum recommended depth of the uncut portion of the stringer is 5 inches. The measurement is to the saw kerf, and it's common to find stringers with dangerously overcut notches (8). Stringers that are overcut have the same potential failures as overspanned stringers. In both cases, they can be repaired by installing intermediate support posts.

RISERS AND TREADS

In both DCA 6 and the 2015 IRC, requirements for riser height and tread depth are 7 3/4 inches (max.) and 10 inches (min.) respectively, though local requirements vary. These measurements are taken at the leading edge of the treads.

To me, the more important safety issue is that the riser heights and tread depths be uniform. Risers or treads that vary more than 3/8 inch between any two risers or treads create a fall hazard, because people become accustomed to a certain feel when using stairs. A variance can cause someone to lose balance and fall. The most common location for a large variance between riser heights is at landings.

Many deck builders seem to be unaware that open risers allowing a 4-inch-diameter sphere to pass through are not permitted on



Though common, 2x4 handrails (9) are not considered graspable and should be avoided. Bottom guard rails on stairs should be oriented close enough to the tread nosings so that a 6-inch-diameter sphere will not pass through the triangle created by the riser, tread, and rail (10). Wooden stair guard posts should be located so that the span between posts (as measured horizontally) is no more than 6 feet. This is a new deck stair that passed inspection (11).

stairs that are more than 30 inches above grade (or the floor below). This is a common defect in older decks, but I often find it on newer decks too.

HANDRAILS

Like deck stair guards, deck stair handrails share the same requirements as for interior stairs, including requirements for a graspable shape and termination in a post or a return. This means that very few deck handrails comply with code or best practices, including those with typical 2x4 and 5/4 rail caps (9). A 2x4 handrail is not graspable, especially by children and others with small hands, the elderly, and those with impaired mobility—the people who need a safe, graspable handrail the most.

Deck stair handrails should also be continuous from above the

top tread or landing to above the last tread in the flight of stairs, and terminate in a return or into a support post. If the guard is properly installed otherwise (which it often isn't), the easiest fix for most handrail problems is to install a separate graspable handrail.

GUARDS

Guards for deck stairs share the same requirements as guards for interior stairs (see "Stair Guard Requirements," page 45). Two of the more common stair-guard defects I see include failing to install vertical infill components so that a 4³/₈-inch-diameter sphere will not pass through, and failing to install the guard bottom rail so that a 6-inch-diameter sphere will not pass through the triangle created by riser, tread, and guard bottom rail (10).

In addition, 4x4 wood support posts for stair guards should be

Guard Post Fastening

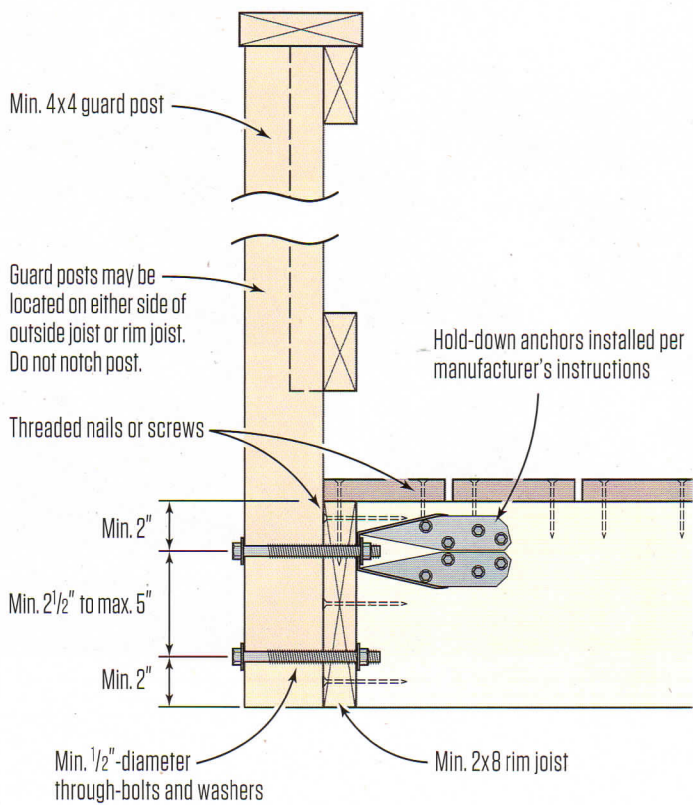

A strong connection between guard posts and deck framing is critical to deck safety. The illustration (above left) shows an example of a connection made with a metal hold-down anchor, and details the other DCA 6 fastening requirements for guard posts. Above all, avoid notched posts (12), which may develop cracks originating in the corner of the notch and running parallel to the grain, which weakens the post.

installed so that they are no more than 6 feet apart. Post spacing must be measured horizontally, not along the length of the guard.

Guard posts must be able to withstand a 200-pound load in any direction. The easiest way to comply with this requirement is to install hold-down connectors, especially at the top of the stairs, following the manufacturer's instructions (see "Guard Post Fastening," above).

Posts should never be notched around the framing, because that practice increases the odds that the post will develop cracks that originate in the corner of the notch and run parallel to the grain, weakening the post (12).

If the bottom guard post extends below grade and also supports the stair stringer, a pair of 1/2-inch-diameter hot-dipped galvanized machine bolts (not carriage bolts) with washers on each

end can be used to fasten the post to the stringer. This same detail can be used with intermediate stair guard posts.

LANDINGS

A solid landing, at least as wide as the stairs and at least 36 inches deep in the direction of travel, should be located at the top and bottom of each flight of stairs. A flight of stairs should not rise vertically more than 147 inches without a landing. An intermediate landing is a small deck, and should be built as such, including appropriate footings, posts, and bracing.

Bruce Barker is a licensed contractor and certified ICC inspector. He owns Dream Home Consultants, in Cary, N.C. A version of this article originally appeared in Professional Deck Builder.